

Impact of implementation of copper phthalocyanine as a second donor on the photosensitive structure characteristic with bulk heterjunction based on PCDTBT and PC₆₁BM

© N.A. Khorshev, M.D. Pavlova, I.A. Lamkin, E. Levin, A.E. Degterev, S.A. Tarasov

St. Petersburg State Electrotechnical University „LETI“
Named after V.I. Ulyanov (Lenin),
197022 St. Petersburg, Russia
e-mail: nakhorshev@etu.ru

Received October 23, 2023

Revised November 21, 2023

Accepted December 14, 2023

The paper presents the process of creating and studying photosensitive structures based on an organic acceptor [6,6]-methyl ester of phenyl-C₆₁-butyric acid (PC₆₁BM) and donors of poly[N-9''-hepta-decanyl-2,7-car-basol-alt-5,5-(4',7'- di-2-tienil-2',1',3'- benzothiadiazole)] (PCDTBT) and copper phthalocyanine (CuPc). Photosensitive structures of the FTO/PCDTBT:PC₆₁BM/InGaSn type were obtained, the spectral response of which lies in the range from 450 to 750 nm, and FTO/PCDTBT:CuPc:PC₆₁BM/InGaSn for which, with the introduction of an additional donor, it was possible to widen the spectral response to the range from 400 to 850 nm. An assumption was made about the formation of additional energy levels in the structure and non-direct transitions between organic donors, as a result of which the spectral response is broadened in both the short-wave and long-wave spectral regions. It was also possible to increase the maximum sensitivity of the structure by almost 3 times from 72 mA/W to 210 mA/W as a result of increasing the number of effective ways of transferring charge carriers to contacts and reducing the energy of potential barriers in the structure. The addition of an additional donor to the structure led to an increase in the currents of the reverse and forward branches of the VAC, a decrease in the level of its own noise and an increase in the short-circuit current. The FTO/PCDTBT:CuPc:PC₆₁BM/InGaSn structure created in the work has a high potential for creating highly efficient photodetectors of the visible and near infrared ranges.

Keywords: Photodetectors, organic semiconductors, phthalocyanines, visible range, infrared radiation.

DOI: 10.61011/EOS.2023.12.58184.5683-23

Introduction

High-performance visible and near-infrared (IR) photodetectors are used nowadays in many optoelectronic applications, such as communication systems, imaging, spectroscopy, medical diagnostics, remote sensing of the atmosphere and environmental control, space research, etc. [1]. Typically, photodetectors based on inorganic semiconductor materials, which require complex manufacturing equipment and processes to produce, are used in these areas. This affects the final cost of the device [2]. These disadvantages can be mitigated by switching to organic semiconductor materials, which combine the possibility of regulating the width of the band gap, a fairly low cost of raw materials and production processes, and the possibility of fabrication of flexible devices. Thus, photodetectors based on organic materials are a promising alternative to currently used devices [3–5].

To create highly sensitive photodetectors in the visible and near-infrared spectral ranges, one needs to select materials in such a way that the obtained samples would have high absorption in the given spectral range and provide efficient generation of excitons and their dissociation with subsequent transfer of free charge carriers to

the corresponding electrodes with minimal recombination, which is ensured by complementarity of HOMO (highest occupied molecular orbital) and LUMO (lowest unoccupied molecular orbital) levels of the organic materials used. The concept of an active layer with a bulk heterojunction, wherein donor-acceptor junctions are spaced by less than the exciton diffusion length, was chosen to produce the samples by premixing the initial materials within a common solvent volume.

Multicomponent structures containing three components in active layers can be used to improve transport properties, reduce the probability of recombination of separated charge carriers, and extend the operating spectral range. Depending on the role of the third component, organic photosensitive structures with one donor and two acceptors or two donors and one acceptor are obtained. Materials with absorption spectra shifted relative to the base materials are typically used as an additional layer to achieve a wider absorption range. In addition, it is also necessary to consider whether the materials have similar energy levels to prevent deep charge trapping. At the same time, good compatibility between several components has a beneficial effect on the morphology of active layers, which is an important factor in the design of efficient photosensitive structures with a

low dark current [6]. However, ternary structures of the composition investigated in this paper have not been studied before.

1. Experiment

Fullerene derivative PC₆₁BM, which is one of the most widely used materials with hole conductivity for high-performance organic photoelectronic devices [7] and features HOMO and LUMO level energies of 6.1 and 3.7 eV, respectively, was chosen as an organic acceptor to create photosensitive structures with a bulk heterojunction. It is well known that the crystallinity of this material in a polymer/PC₆₁BM mixture plays a crucial role in photovoltaic conversion, and its high solubility in such commonly used solvents as chlorobenzene, toluene, and chloroform ensures high-quality surface morphology of organic photovoltaic devices [8].

To investigate the photosensitivity spectra and voltammetric characteristics, structures were deposited onto conductive substrates (glass with a pre-applied FTO layer). This conductive layer was chosen because of the proximity of its work function to the energies of HOMO levels of donor materials. A eutectic alloy based on gallium, indium, and tin (InGaSn) was used as the second contact, since its work function of 4.5 eV is close to the LUMO energy level of the organic acceptor used.

PCDTBT, which is one of the most widely studied organic donor polymers, was chosen as an organic donor. It has a relatively high solubility, high internal quantum efficiency, high power conversion efficiency, and thermal stability [9]; its HOMO and LUMO energies (5.5 and 3.6 eV) are close to the corresponding levels of PC₆₁BM. However, photosensitive structures based on this organic donor have insufficiently high sensitivity in a narrow spectral range [10]. To compensate for these shortcomings, CuPc, which has a high absorption coefficient in the longer-wavelength region of the spectrum relative to PCDTBT [11], was used as an additional donor that can (theoretically) broaden the photosensitivity spectrum. The HOMO and LUMO level energies of CuPc are 5.2 and 3.5 eV, respectively. Its HOMO level energy lies between the work function of 5 eV of fluorine-doped tin oxide (FTO), which was used as one of the electrodes, and the HOMO level energy of PCDTBT, potentially providing a more efficient charge carrier transport. Thus, the introduction of an additional organic donor in the form of CuPc should lead to an increase in the sensitivity of the created structures. The energy diagram of the structure based on FTO/PCDTBT:PC₆₁BM/InGaSn is shown in Fig. 1.

After the introduction of a second donor in the form of CuPc into the structure, the energy diagram assumes the form shown in Fig. 2. It is noticeable that, as noted earlier, with this arrangement of energy levels, the transport of charge carriers to the corresponding electrodes is simplified.

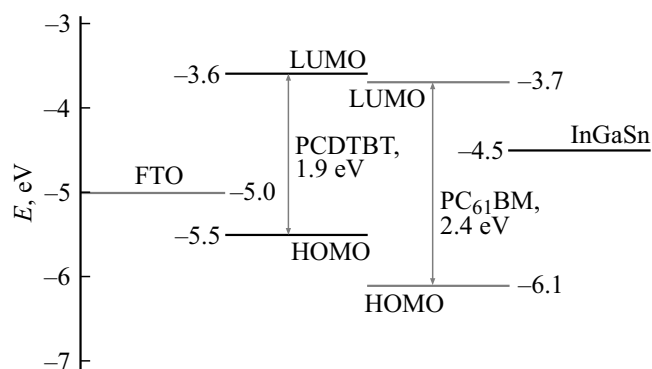

Figure 1. Energy diagram of structure FTO/PCDTBT:PC₆₁BM/InGaSn.

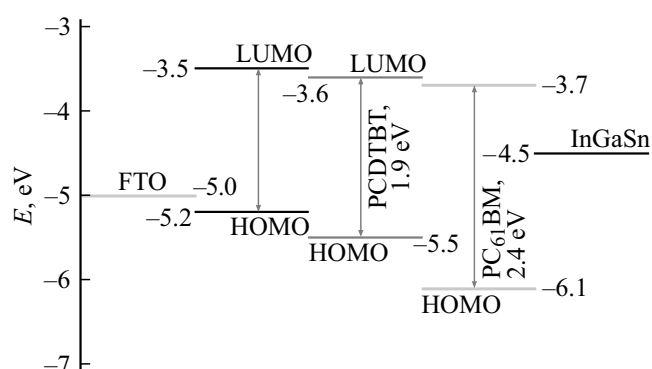

Figure 2. Energy diagram of structure FTO/PCDTBT:CuPc:PC₆₁BM/InGaSn.

To create photosensitive structures of the visible spectrum range with a bulk heterojunction, organic materials were dissolved in a common solvent volume. Chlorobenzene was chosen as this solvent, since all organic materials used in this work are highly soluble in it. The prepared solution consisted of 4 mg PCDTBT, 16 mg PC₆₁BM, and 1 ml chlorobenzene. A similar ratio was used in [12] to obtain a PCDTBT:PC₇₁BM structure. Thin photosensitive films were deposited using the centrifugation method. It was found experimentally that the application of these organic materials at a centrifuge rotation speed of 1200 min⁻¹ is optimal for obtaining uniformly thick films with a high absorption coefficient. At this speed of rotation of the substrate in the process of solution application, the smallest average variation of absorption coefficient over the sample surface is achieved, which is demonstrated in Fig. 3. Accordingly, the most uniform distribution of material over the surface is obtained.

To create a sample with two donors, 10 mg CuPc and 0.5 ml chlorobenzene were added to the mixture, which turned out to be the optimal amount for the given ratio of materials already used, as the highest values of photocurrents of the samples were obtained in this case (see Fig. 4).

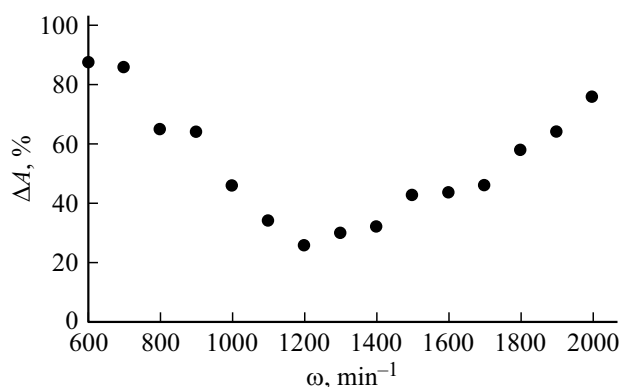

Figure 3. Effect of substrate rotation speed on the average variation of absorption coefficient over the surface of samples.

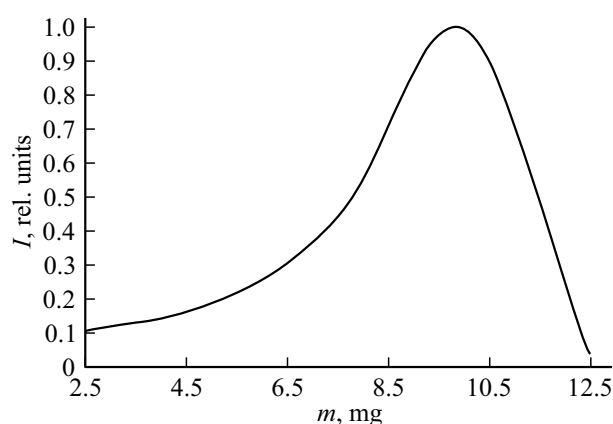

Figure 4. Dependence of the photocurrent of the FTO/PCDTBT:CuPc:PC₆₁BM/InGaSn structure on the mass of CuPc in the mixture.

After application, the samples were annealed at a temperature of 100°C, which was chosen because of the structural properties of PCDTBT that has all alkyl chains attached to the same segment. This allows the alkyl-free side of the PCDTBT to bond, but as the temperature increases, this feature gradually vanishes and different ordering emerges, indicating a phase transition within the PCDTBT phase that ends at about 140°C [13].

2. Analysis of results

Figure 5 shows the absorption spectra of the deposited thin films based on PCDTBT, PC₆₁BM, CuPc, and their mixtures (PCDTBT:PC₆₁BM and PCDTBT:CuPc:PC₆₁BM). The PCDTBT-based film has a fairly high absorption within the entire visible range, and the highest absorption is observed at ~530–620 nm. Since the highest absorption of the PC₆₁BM-based film is in the blue-green region of the spectrum, a mixture of these materials should have high absorption within the entire visible wavelength range. As can be seen, the fabricated samples based on PCDTBT:PC₆₁BM have fairly high absorption in the wavelength range of

400–650 nm with absorption peaks at 425 and 565 nm. Experimental studies revealed the emergence of a relatively narrow maximum in the absorption spectrum of the PCDTBT:PC₆₁BM mixture at a wavelength of 425 nm. Its presence is attributed to the coupling of absorption processes in materials with absorption at 450–500 nm in PC₆₁BM decreasing in the double structure, which can be explained by the switching of transitions to PCDTBT. This effect is even more evident in the triplet structure, where the absorption in PC₆₁BM is minimal. As was noted above, CuPc, which has high absorption in the wavelength range of 550–750 nm, was added to the structure to enhance the photoresponse in the long-wavelength region. The obtained film based on PCDTBT:CuPc:PC₆₁BM has high absorption in the wavelength range of 400–750 nm. As expected, CuPc added to the structure broadened the absorption spectrum towards longer wavelengths.

After studying the absorption spectral characteristics, the photosensitive structures with a bulk heterojunction were investigated. The photosensitivity spectra of FTO/PCDTBT:PC₆₁BM/InGaSn and FTO/PCDTBT:CuPc:PC₆₁BM/InGaSn samples shown in Fig. 6 were examined. For the first structure, the spectrum covers the whole visible range and has a photosensitivity maximum at a wavelength of 620 nm, which corresponds to optical transitions in PCDTBD with a band gap of 1.9 eV. The highest photosensitivity value for this sample was 72 mA/W. The second structure, with CuPc added to the mixture, is sensitive throughout the visible range and also covers a part of the near-IR spectrum (400 to 850 nm), as seen in Fig. 6, *a*. The broadening of the photosensitivity spectrum of this structure is caused by the following processes: photon absorption due to intracenter transitions in CuPc similar to those described in [14] and, based on the energy band diagram of the structure, an assumption was made about the presence of transitions between PCDTBT and CuPc. Such transitions lead to the formation of excitons with higher energies, which explains broadening in the blue region of the spectrum, as well as excitons with lower

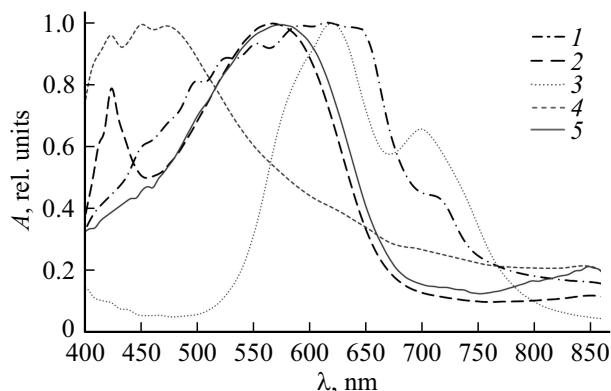

Figure 5. Absorption spectra of samples synthesized in the work on the basis of pure materials and mixtures PCDTBT:CuPc:PC₆₁BM (1), PCDTBT:PC₆₁BM (2), CuPc (3), PC₆₁BM (4) and PCDTBT (5).

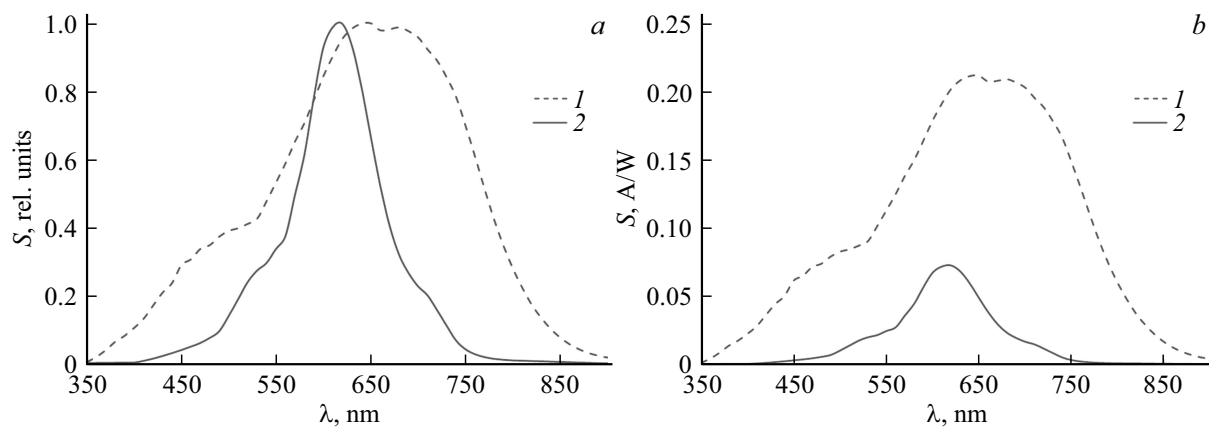

Figure 6. Photosensitivity spectra of structures of the FTO/PCDTBT:CuPc:PC₆₁BM/InGaSn (1) and FTO/PCDTBT:PC₆₁BM/InGaSn (2) type in relative (a) and absolute (b) units.

energies compared to the structure with one organic donor. In addition, due to the mutual arrangement of energy levels, CuPc probably acts as a channel facilitating the transport of holes generated in PCDTBT to the anode, while also being a barrier for electrons due to the higher value of the HOMO level energy. Thus, the probability of charge carrier recombination is reduced and charge carrier collection is improved, resulting in an increased photosensitivity within the entire spectral range. The photosensitivity spectrum shown in Fig. 6, b shows a peak at a wavelength of about 620 nm that is typical of the structure without CuPc. It is induced by optical transitions of PCDTBT and shifted toward longer wavelengths due to the influence of CuPc on the structure of PCDTBT, resulting in the absorption of photons with transitions between the levels of two donors the energy of which is lower than that of optical transitions inside PCDTBT. An additional maximum appears at a wavelength of 680 nm, which is attributable to optical transitions in CuPc. The highest value of photosensitivity of this structure was 210 mA/W.

The introduction of an additional donor (CuPc) into the structure allowed, as expected, to broaden the photosensitivity spectrum and to increase the photoresponse by a factor of almost 3, as shown in Fig. 6, a. This is attributable to the formation of an additional heterojunction between CuPc and PC₆₁BM, which provides a more efficient dissociation of excitons, in the ternary structure with a bulk heterojunction, as well as to a more efficient transport of charge carriers to the contacts by virtue of a larger number of effective transport pathways (see [6] for details) and to lowering of potential barriers due to the positioning of the CuPc energy level between the energy levels of PCDTBT and the contact in the structure. As a consequence, the number of photo-generated charge carriers arriving at the contacts increases, leading to a significant increase in photocurrent. One of the main problems in achieving high efficiency in tandem photosensitive structures is the difference in open-circuit voltages for different materials [15]. However, in the FTO/PCDTBT:CuPc:PC₆₁BM/InGaSn structure, this

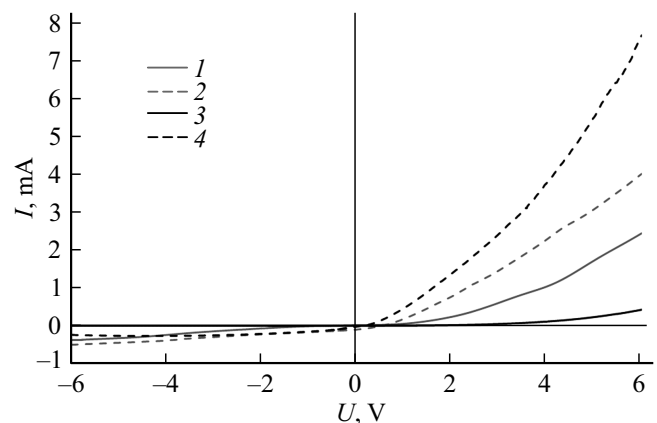

Figure 7. VACs of samples based on FTO/PCDTBT:PC₆₁BM/InGaSn structures: 1 — dark branch, 2 — light branch; and FTO/PCDTBT:CuPc:PC₆₁BM/InGaSn: 3 — dark branch, 4 — light branch.

is mitigated due to mixing of materials, which leads to voltage equalization and, consequently, an increase in the photosensitivity of the structure.

In order to determine the electrical characteristics of the created samples, the VACs of FTO/PCDTBT:PC₆₁BM/InGaSn and FTO/PCDTBT:CuPc:PC₆₁BM/InGaSn structures were studied (see Fig. 7). The increase in current under forward bias is attributed to the formation of photogenerated additional charge carriers under irradiation; however, the first structure has low operating characteristics and a rather high noise level compared to operating currents, which is due to the fact that the number of charge carriers formed during illumination is small relative to the number of injected ones. The short-circuit current for this sample was 9.09 μ A, and the open-circuit voltage was 0.5 mV. The short-circuit current of the sample based on FTO/PCDTBT:CuPc:PC₆₁BM/InGaSn was 19.1 μ A, more

than 2 times higher than that of the sample without added CuPc; the open-circuit voltage was 0.15 mV.

It is evident that the addition of a second donor to the structure improves the photoresponse of the sample in both forward and reverse branches of the VAC and reduces its noise level, making such a structure applicable in the design of efficient photodetectors of the visible and near-infrared spectral range.

Conclusion

The results of studies into the fabrication of organic photosensitive structures of the visible range with a bulk heterojunction and the examination of influence of a second donor added to the structure were presented. An FTO/PCDTBT:PC₆₁BM/InGaSn photosensitive structure with a spectral response from 450 to 750 nm was fabricated. Its maximum photosensitivity value was 72 mA/W. Following the introduction of an additional donor (CuPc) into the active layer, a structure of the FTO/PCDTBT:CuPc:PC₆₁BM/InGaSn type was formed. It had a significantly wider photosensitivity range (400–850 nm), and its peak sensitivity was almost three times higher: 210 mA/W. At the same time, the voltammetric characteristics of the structure with an additional donor show an increase in both forward and reverse branch currents, an increase in short-circuit current, and a decrease in intrinsic noise compared to the structure with a single organic donor. Thus, it can be concluded that the obtained structure with two organic donors can be used as an active element of photodetectors in the visible and near-infrared spectral range.

Acknowledgment

The study was conducted as part of project No. FSEE-2022-0016.

Conflict of interest

The authors declare that they have no conflict of interest.

References

- [1] C. Zhao, J. Wang, X. Zhao, Z. Du, R. Yang, J. Tang. *Nanoscale*, **13**, 2181 (2021). DOI: 10.1039/D0NR07788G
- [2] N.A. Kulchitsky, A.V. Naumov, V.V. Photonics, **14** (3), 234 (2020). DOI: 10.22184/1993-7296.FRos.2020.14.3.234.244
- [3] G. Liang, Z. Zhi-Guo, B. Haijun, X. Lingwei. *High-Efficiency Nonfullerene Adv. Mater.*, **28**, 8288 (2016). DOI: 10.1002/adma.201601595
- [4] Y. Lin, J. Wang, Z. Zhang, H. Bai. *Adv. Mater.*, **27**, 1170 (2015). DOI: 10.1002/adma.201404317
- [5] W. Zhao, D. Qian, S. Zhang, S. Li. *Adv. Mater.*, **28**, 4734 (2016). DOI: 10.1002/adma.201600281
- [6] Wang X., Sun Q., Gao J. et al. *Energies*, **14**, 14 (2021). DOI: 10.3390/en14144200
- [7] G. Bernardo, M. Melle-Franco, A.L. Washington, R.M. Dalgliesh. *RSC Advances*, **10**, 4512 (2020). DOI: 10.1039/C9RA08019H
- [8] R. Ramani, S. Alam. *Polymer*, **54** (25), 6785 (2013). DOI: 10.1016/j.polymer.2013.10.023
- [9] R. Roesch, K.R. Eberhardt, S. Engmann, G. Gobsch, H. Hoppe. *Solar energy materials and solar cells*, **117**, 59 (2013). DOI: 10.1016/j.solmat.2013.05.013
- [10] T.Y. Chu¹, S. Alem, P.G. Verly, S. Wakim. *Appl. Phys. Lett.*, **95** (6), (2009). DOI: 10.1063/1.3182797
- [11] A.A. Farag. *Optics & Laser Technology*, **39** (4), 728 (2007). DOI: 10.1016/j.optlastec.2006.03.011
- [12] V.S. Murugesan, S. Ono, N. Tsuda, J. Yamada, P.K. Shin, S. Ochiai. *International Journal of Photoenergy*, 687678, (2015). DOI: 10.1155/2015/687678
- [13] X. Lu, H. Hlaing, D.S. Germack, Jeff Peet et al. *Nature Communications*, **3** (795), (2012). DOI: 10.1038/ncomms1790.
- [14] S.M. Sawanta, D.S. Dalavi, P.N. Bhosale, C.A. Betty, A.K. Chauhan, P.S. Patil. *RSC Advances*, **5**, 2100 (2012). DOI: 10.1039/c2ra00670g
- [15] L. Meng, Y. Zhang, X. Wan, C. Li, X. Zhang, Y. Wang, X. Ke, Z. Xiao, L. Ding, R. Xia, H. Yip, Y. Cao, Y. Chen. *Science*, **361** (6407), 1094 (2018). DOI: 10.1126/science.aat2612

Translated by D.Safin